

# INSTRUCTION MANUAL



**SANTA IZABEL**  
Agricultural Implements

**LIGHT HARROW  
REMOTE CONTROL**

**GLCR**  
12 | 14 | 16 | 18 | 20 | 24



**INTERMEDIATE HARROW  
REMOTE CONTROL**

**GICR**  
14 | 16 | 18 | 20 | 24 | 28



APRIL 2012

## TECHNICAL INFORMATION

### LIGHT HARROW REMOTE CONTROL

## GLCR

12 | 14 | 16 | 18 | 20 | 24



### INTERMEDIATE HARROW REMOTE CONTROL

## GICR

14 | 16 | 18 | 20 | 24 | 28



Code	Model	Ø Discs	Ø Discs Axles	Disc Spacing	Cut Width	Approximate Weight	Indicated Power CV (Tractor)
10.33.0030	GLCR 12	24"	1.5/8"	230 mm	1480 mm	1454 Kg	65 - 75
10.33.1029	GLCR 12	26"	1.5/8"	230 mm	1480 mm	1484 Kg	65 - 75
10.33.0031	GLCR 12	28"	1.5/8"	230 mm	1480 mm	1568 Kg	65 - 75
10.33.1028	GLCR 14	24"	1.5/8"	230 mm	1676 mm	1605 Kg	75 - 80
10.33.1033	GLCR 14	26"	1.5/8"	230 mm	1676 mm	1641Kg	75 - 80
10.33.0034	GLCR 14	28"	1.5/8"	230 mm	1676 mm	1738 Kg	75 - 80
10.33.1037	GLCR 16	24"	1.5/8"	230 mm	1863 mm	1749 Kg	80 - 90
10.33.1035	GLCR 16	26"	1.5/8"	230 mm	1863 mm	1790 Kg	80 - 90
10.33.0038	GLCR 16	28"	1.5/8"	230 mm	1863 mm	1901 Kg	80 - 90
10.33.1009	GLCR 18	24"	1.5/8"	230 mm	2088 mm	1790 Kg	95 - 100
10.33.1005	GLCR 18	26"	1.5/8"	230 mm	2088 mm	1836 Kg	95 - 100
10.33.0007	GLCR 18	28"	1.5/8"	230 mm	2080 mm	1887 Kg	95 - 100
10.33.1010	GLCR 20	24"	1.5/8"	230 mm	2300 mm	1858Kg	100 - 120
10.33.1006	GLCR 20	26"	1.5/8"	230 mm	2300 mm	1909 Kg	100 - 120
10.33.0011	GLCR 20	28"	1.5/8"	230 mm	2300 mm	1965 Kg	100 - 120
10.33.1013	GLCR 24	24"	1.5/8"	230 mm	2556 mm	2074 Kg	140 - 160
10.33.1014	GLCR 24	26"	1.5/8"	230 mm	2556 mm	2136 Kg	140 - 160
10.33.0015	GLCR 24	28"	1.5/8"	230 mm	2556 mm	2203 Kg	140 - 160

Code	Model	Ø Discs	Ø Discs Axles	Disc Spacing	Cut Width	Approximate Weight	Indicated Power CV (Tractor)
10.33.1001	GICR 14	26"	1.5/8"	270 mm	1968 mm	1613 Kg	80 - 90
10.33.0001	GICR 14	28"	1.5/8"	270 mm	1968 mm	1652 Kg	80 - 90
10.33.1002	GICR 16	26"	1.5/8"	270 mm	2178 mm	1865 Kg	95 - 105
10.33.1003	GICR 16	28"	1.5/8"	270 mm	2178 mm	1910 Kg	95 - 105
10.33.2001	GICR 18	26"	1.5/8"	270 mm	2402 mm	1867 Kg	110 - 120
10.33.2002	GICR 18	28"	1.5/8"	270 mm	2402 mm	1918 Kg	110 - 120
10.33.1005	GICR 20	26"	1.5/8"	270 mm	2639 mm	1964 Kg	120 - 140
10.33.1004	GICR 20	28"	1.5/8"	270 mm	2639 mm	2020 Kg	120 - 140
10.33.1006	GICR 24	26"	1.5/8"	270 mm	3136 mm	2246 Kg	145 - 160
10.33.0003	GICR 24	28"	1.5/8"	270 mm	3136 mm	2313 Kg	145 - 160
10.33.1008	GICR 28	26"	1.5/8"	270 mm	3659 mm	2445 Kg	170 - 180
10.33.0004	GICR 28	28"	1.5/8"	270 mm	3659 mm	2523 Kg	170 - 180

"According to the continuous improvement program for the products of the company, the specifications contained herein may be changed without prior notice and without the commitment of altering pieces of equipment previously manufactured."



## LIGHT HARROW REMOTE CONTROL

# GLCR

12 | 14 | 16 | 18 | 20 | 24



## INTERMEDIATE HARROW REMOTE CONTROL

# GICR

14 | 16 | 18 | 20 | 24 | 28



### To the owner

- This manual should be handed to the operators and maintenance staff.
- Upon receiving it, it is important to check the conditions of the product.
  - Request the completion of the warranty certificate.
- The information contained herein indicates the best use and allows the maximum performance of the implement, increasing its useful life.

The manual contains several pieces of information related to the operation, adjustment, and maintenance.  
The operator should carefully read it before putting the implement into operation.



Illustration

# GLCR

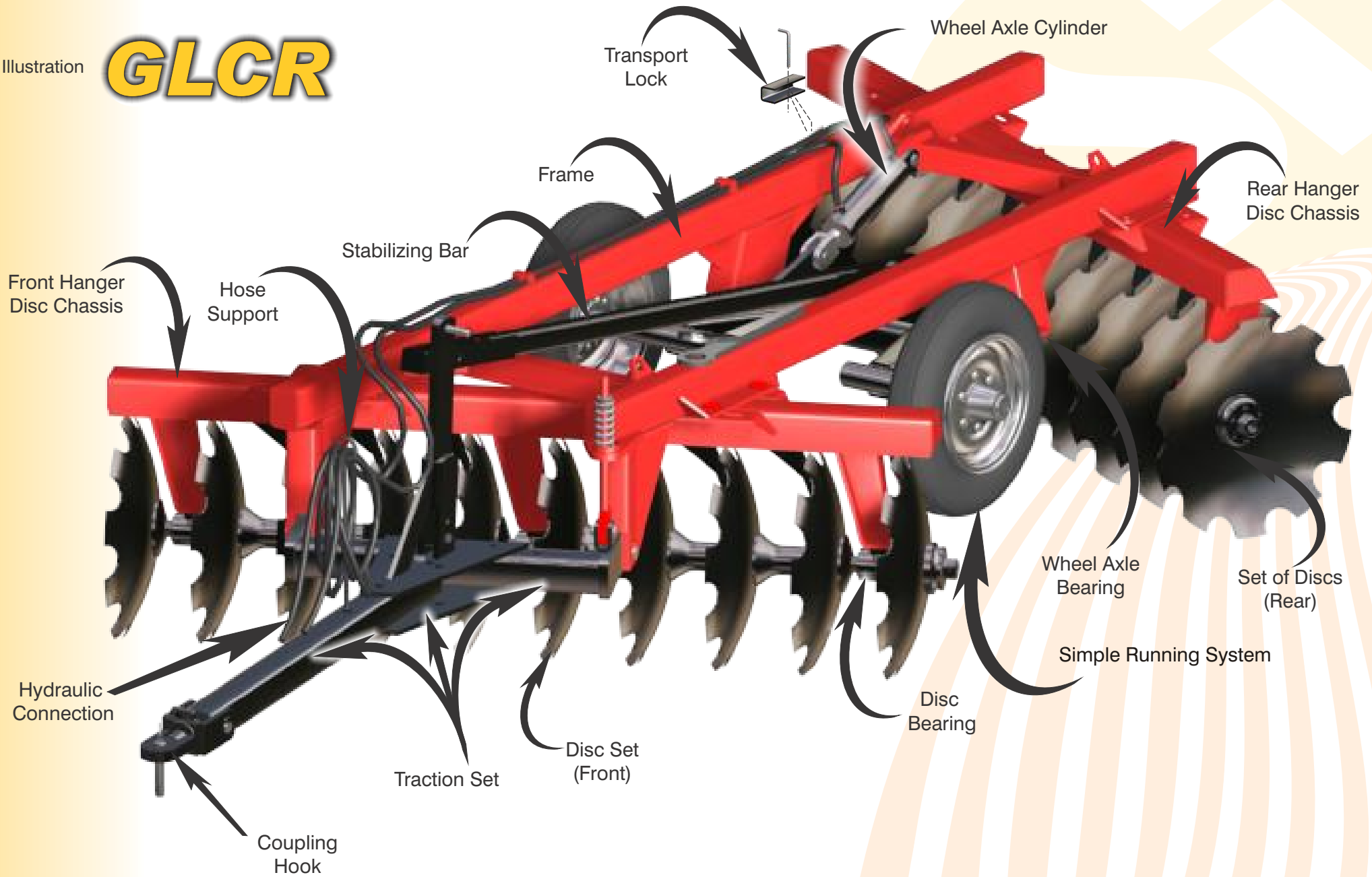

## TO THE OPERATOR

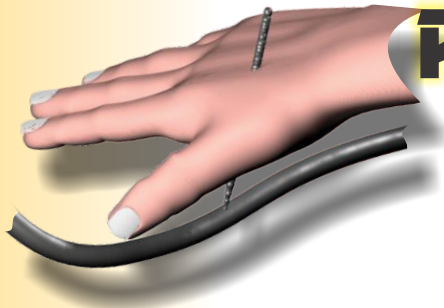

# PRECAUTIONS

- The maintenance can be considered a set of procedures aiming to keep the equipment in the best working conditions, propitiating the increase of the useful life, preventing premature damages, eliminating the ones observed and meeting a higher safety at work.

- For the operator's safety, it is necessary to comply with the safety recommendations contained in this manual, demanding however, the basic and indispensable care in its handling.

- During work, transport, maintenance and storing, full attention, observation and recommendation are the main requirements for the safety of those operating the equipment.

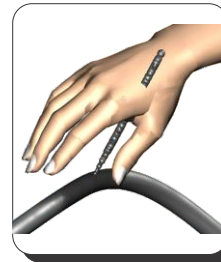

Do not verify leakings on the hydraulic circuit with your hands, as the high pressure may cause serious injuries.

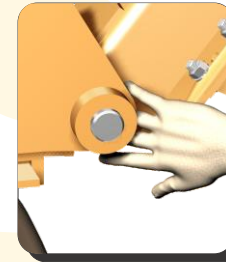

Never try to adjust or have the maintenance service with the machine in motion.

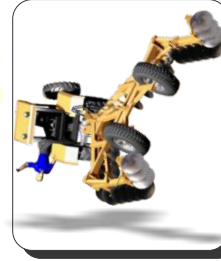

Take special care when circulating on a slope. Risk of overturning.

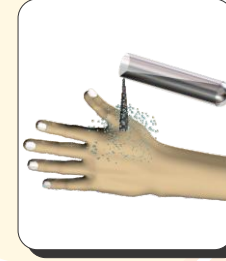

Prevent chemical products (fertilizers, pesticides, etc) to come into contact with the skin or clothes.

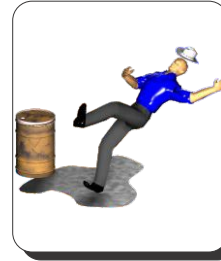

Keep the access and work places clean and free of oil, grease, etc. Risk of accident.



In manoeuvring or in a sharp turn, avoid the tractor wheels touching the header.



Do not transport people if there is not an additional seat for such purposes.



Be careful when circulation under high voltage power cable.



Always wear safety shoes during work.

## SAFETY

In order to transport and operate these products, it is mandatory the operators to be responsible and prepared / with technical knowledge.

It is prohibited the transport of passengers on top of the equipment.

Do not make adjustments, clean or lubricate with equipment operating.

Always switch off the engine when leaving the truck's seat.

Use adequate clothes and shoes. (Avoid loose clothes and open shoes)

Use personal protective equipment – PPE

Undertake a survey of the area and use the suitable speed to the terrain conditions.

Always make sure to attach the security chain between the truck and the cart (if applicable)

Before starting the truck, make sure the pneumatic air system (compressed air) is fully loaded to liberate the emergency break.

Every time you disengage the transshipment from the truck, do it in a plain and firm place, and make sure it is properly supported and underlay the wheels.

Do not allow children to play near or on top of the equipment in operation, transport or storage.

Do not transit on the highway or paved roads, without the appropriate documentation.

Always use the seat belt.

## TECHNICAL SPECIFICATIONS

### P.P.E. USE (OBLIGATORY)

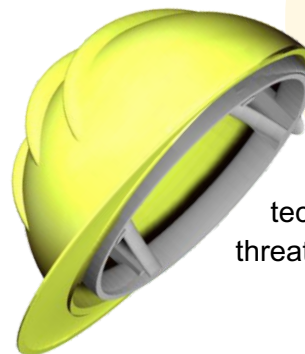

Personal Protective Equipment – PPE is every device or product individually used by the worker, destined to protect against risks capable of threaten his safety and health.



### PRESERVE THE ENVIRONMENT

Never adopt actions that can provoke damages to the environment as, for example, pouring oil, fuel, filters, batteries, etc on the soil which affects the ecology directly, taking these residues to the groundwaters.

Two suggestions would be creating a solid residues recycle system inside the company or dispose these contaminant elements in a correct way to those who may recycle or reuse, so with these attitudes you will be contributing to the environment.



## ATTENTION

- During work or transport it is allowed only the tractor operator to stay.
- Do not let children to play near or on the plough, being it in operation, transport and storage.
- Bear the complete knowledge of the terrain before starting the harrowing.
- Make the demarcation of hazardous locations and obstacles.
- Use the appropriate speed to the ground conditions or paths.
- Use personal protective equipments.
- Use appropriate clothes/shoes. Avoid loose clothing that can become entangled in moving parts.
- Never operate without the protection devices of the machine.
- Be careful when making the coupling on the drawbar.
- Wear protection gloves to work next to the discs.
- When placing the plough in the transport position note if there are no people or animals coming.
- Never try to change the adjustments, clean or lubricate the plough in movement.
- Always stop the engine before leaving the tractor seat.
- Pull the plough only with the tractor of appropriate power.
- Pay attention to the transport width in narrow places.
- Every time the plough is disengaged, in the farming or shed, do it in a plan and firm site. Make sure it is properly supported.

## TRANSPORT ON TRUCK / CART

The long distance transport shall be made on truck / cart, etc... following these security instructions :

- Use appropriate ramps to load and unload the plough. Do not make the loading in the banks, because may occur serious accidents.
- In case of winch lifting use points suitable for hoisting.
- Adequately support the plough.
- Use tethers (cables, chains, ropes, etc...) in sufficient quantity to immobilise the plough during transport.
- Check the conditions of the load after the first 8 to 10 kilometers of travel, then every 80 to 100 kilometers check if the ropes are not loosening. Check the load with more frequency on bumpy roads.
- Always be alert. Be careful with the height of transport, especially on electrical network, viaducts, etc. ...
- Always check the current legislation on the limits of height and width of the load. If necessary, use flags, lights and reflectors to alert other drivers.



# ASSEMBLY

## *IMPORTANT :*

- *Read this manual carefully before beginning the operation of the equipment;*
- *SANTA IZABEL implements are supplied partially disassembled. To assemble them, carefully follow the instructions contained in this manual;*
- *Assembly involves the use of a crane, tow truck or any other equipment that allows raising the parts of the implement or the implement itself safely;*
- *Before starting the assembly, it becomes necessary to clean and lubricate the components.*

*NOTE: The right and left sides of the plough are in the same arrangement of the tractor, seen from behind.*





## USE OF THE SET OF KEYS

Use the keys (A and B) in tightening of nuts from sections of discs, being one to hold the axle nut on one side, while tightening the nut on the other end; thus avoiding that the axle rotate.

The keys (C and D) are used for tightening the nuts of the screws of the bearings, for tightening of nuts and traction for tightening the nuts of the screws that attach the hanger disc chassis to the framework and cleaners.

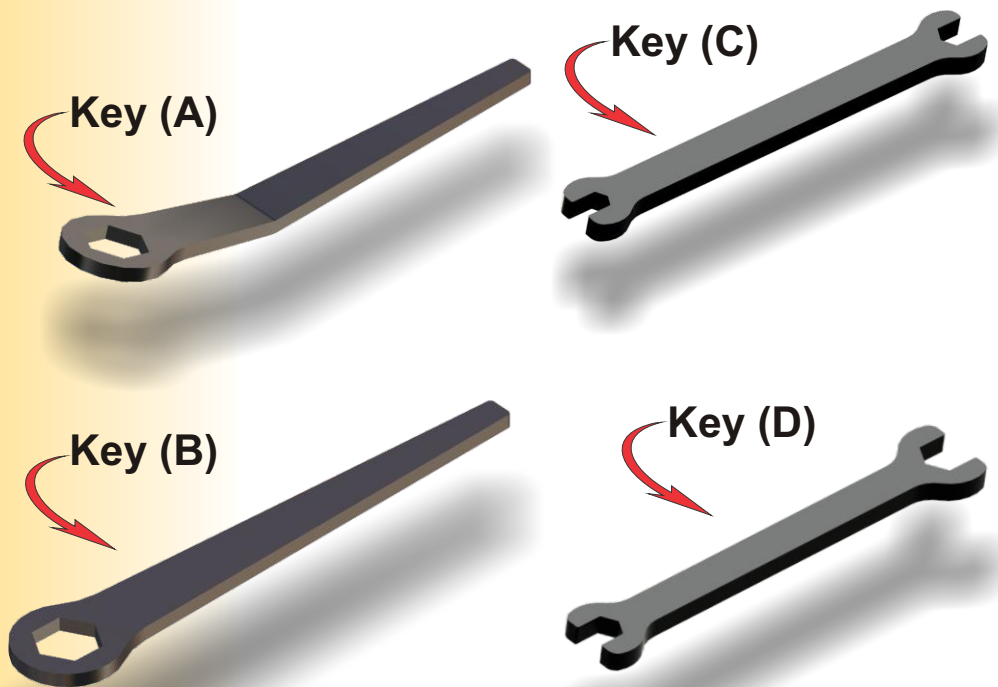

## SEQUENCE OF DISC SET ASSEMBLY

- **ATTENTION:** The use of gloves is recommended to assemble the disc sections.
- **IMPORTANT:** Check the correct side of the bearings and disc spacers.

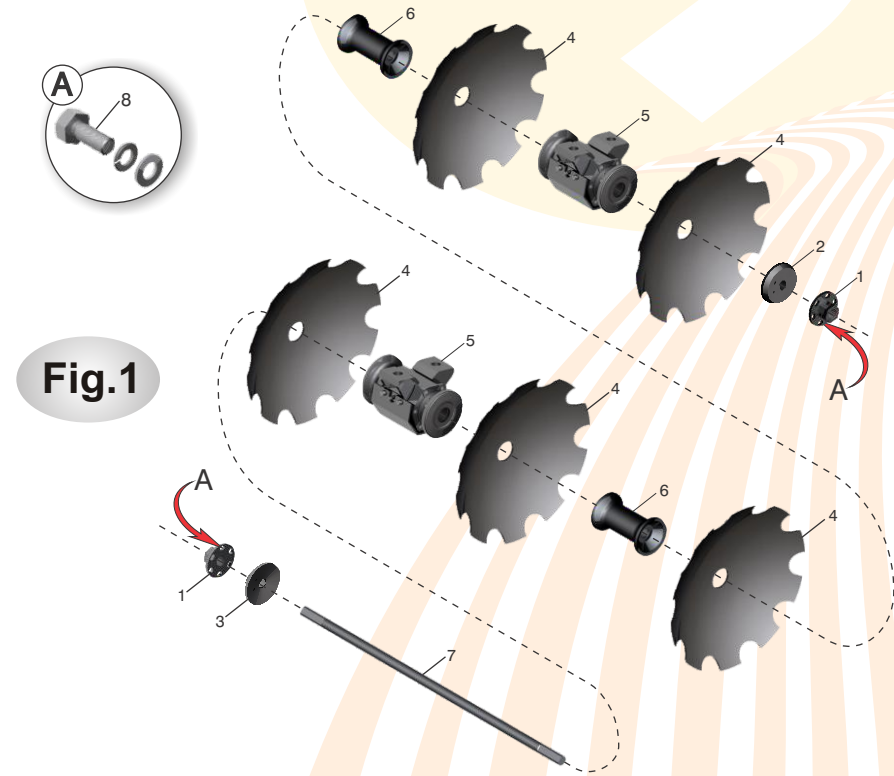

Hold the axle (7) and one of the ends, place the external abutment (3) and then screw the left nut (1) until facing the tip of the axle, leaving it to be tightened at the end of the assembly. The first disc is assembled (4), along with bearings, spacers, and other components as per sequence of figure 1.

Finally, set up the internal abutment (2) and the nut (1), tightening with the wrench (10) until the set is totally firm. This nut should be locked, thus the holes of the nut and the abutment must coincide. Use the screw (8) for locking.

Once this is done, with the wrench (10) and its handle standing on the ground, tighten with the wrench (11) from the external side of the disc (use a 5 kg mallet approximately and about 70 cm of wire) until reaching maximum torque, seeking to coincide the holes of the nut with the holes of the external abutment. This nut should be locked. Use the screw (8) to lock it. Figures 2 and 3.

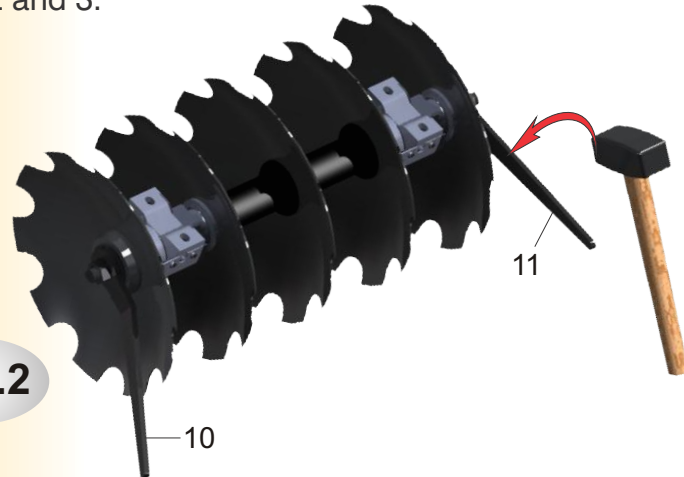

Fig.2

**NOTE:** To prevent the disc set from moving, it is necessary to wedge it with pieces of wood or similar objects.

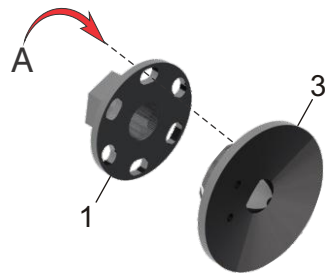

Fig.3

**NOTE:** For longer durability of the equipment, check if all axle components are adjusted.

**OBS.:**

For the locking, coincide 2 nut oblongs with two holes of the abutment, as per figure 3.

## ASSEMBLY OF DISC SETS IN THE CHASSIS

After fixing the disc sets in the chassis, observe the bearing stands in relation to the concavity of the discs (figure 4).

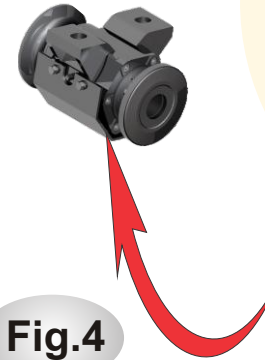

Fig.4

Its fixation is made with screws, washers, nuts, and check nut as per sequence of figure 5.

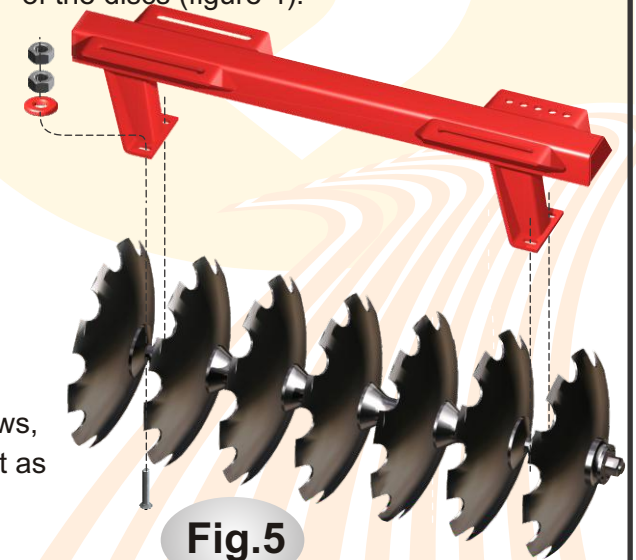

Fig.5

### CLEANER ASSEMBLY

- There are front and rear cleaners.
- During assembly, make sure their rods are turned to the concave side of the discs.
- They are adjustable and allow proximity with the discs.
- French screws with nuts and washers allow their fixation (figure 6).

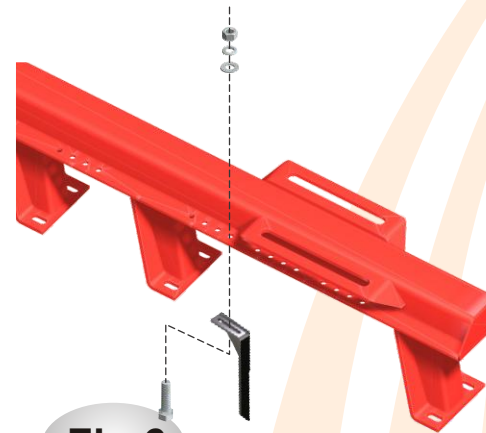

Fig.6

# ASSEMBLY

## ASSEMBLY OF THE CHASSIS IN THE FRAME

Fixate the hanger disc chassis (front and rear) in the frame (A), through nuts, washers and nuts (B).

*Obs.: See adjusting the opening by fixation holes on page 14*

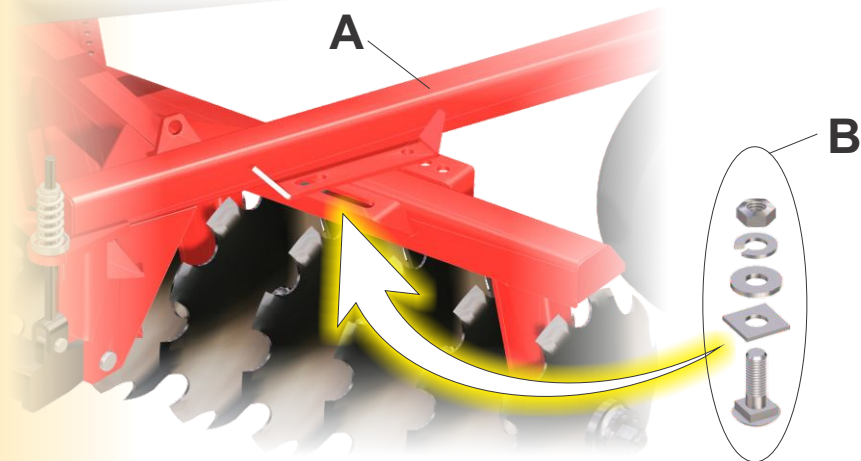

## TIRES ASSEMBLY

Attach the tires (A) to the cubes (B), using the nuts attached.

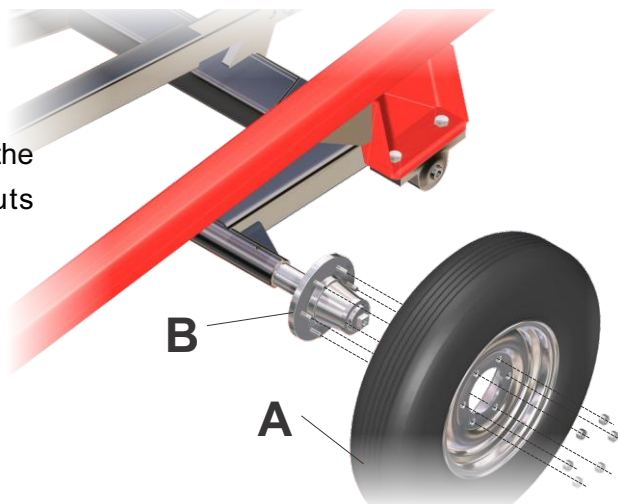

## ASSEMBLY OF THE HOSES

Make the assembly of the hoses (A) in the hydraulic cylinder (B), with enough tightening and avoid the terminals touching the ground.

**NOTE:** - The terminals of the cylinder must remain facing upwards.  
- Always use "thread lock" to couple the "male" quick couplings to the hoses and cylinders.

As a result, attach the hose support (C) to the drawbar.

Also attach the fasteners (AND) to the frame, through screws.

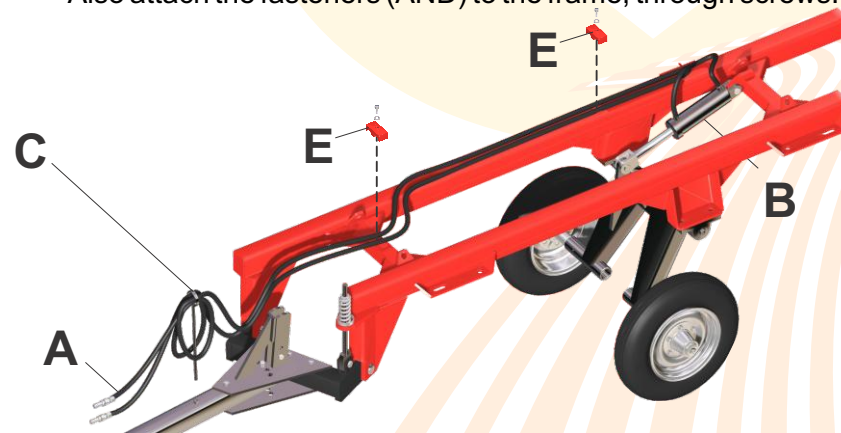

## ASSEMBLY OF THE TRACTION SET

Attach the traction bar (A) to the plates (B), using screws (C), lock washers and nuts.

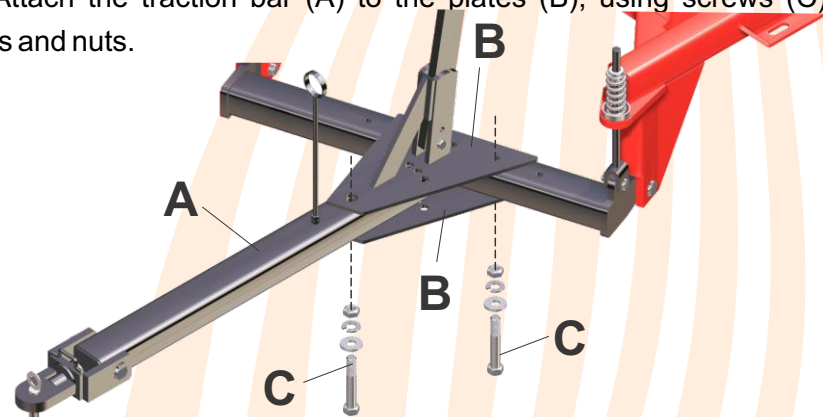

## ASSEMBLY OF THE HYDRAULIC SYSTEM

- Set up the hydraulic cylinder in the frame and in the wheel axle;
- Couple the hoses in the cylinder and fix them to the frame with clamps and screws;
- Use the hose support fixed to the strap set to guide them to the tractor, as per figure 8.

**Fig.8**

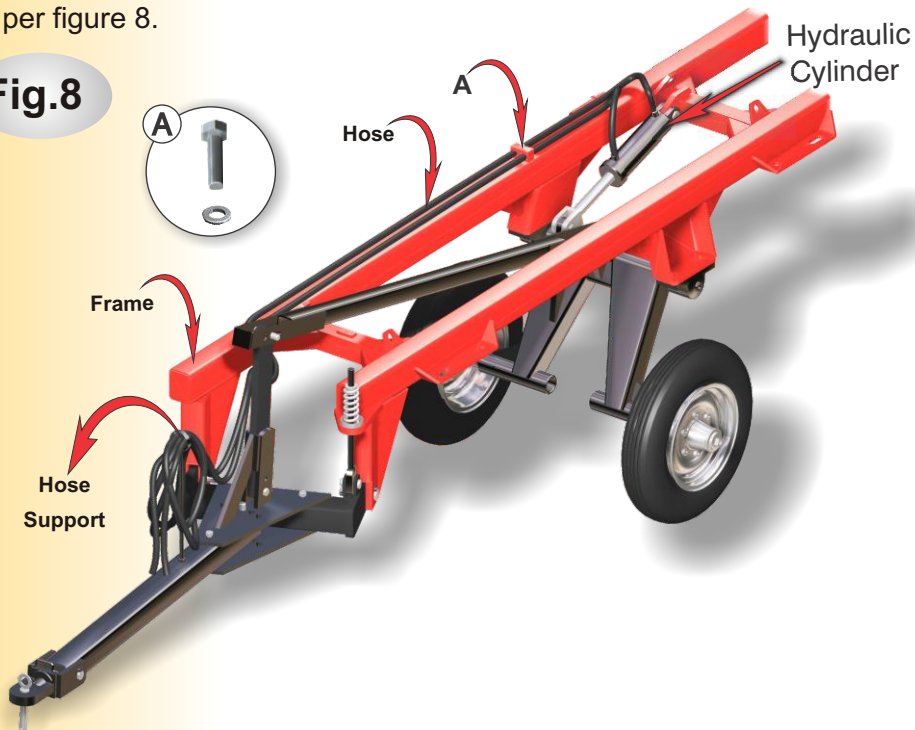

## TRACTOR COUPLING

To couple the implement to the tractor, bring it closer to the equipment header and couple the hoses to the quick couplings. This is done with the engine off: relieve the command pressure by activating the control lever a few times.

Check if the couplings are clean.  
(See figure 9)

To facilitate coupling the plough to the tractor, proceed as follows:

**Fig.09**

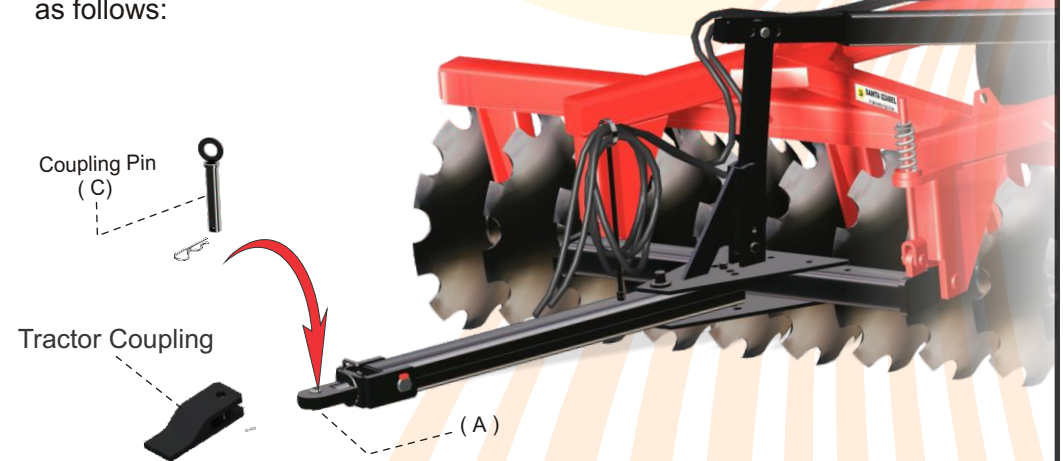

## INSTRUCTIONS ON OPERATIONS AND ADJUSTMENTS

For maximum performance when operating the equipment, we suggest you to carefully read the instructions below.

It is suitable to observe that adding water ballast to the tires and set of weights to the front and rear wheels are the most used forms to increase soil traction and provide more stability to the tractor.

the command by lowering the tires until you are able to place the pin (C) in the hole (A)

## ***IMPORTANT RECOMMENDATIONS***

- The tractor traction bar must remain loose in operation and fixed to the carriage.
- Never remove the hoses without before lowering the plough and relieve the pressure of the command.
- The spring in the header must be adjusted on a plan and firm site, with the grid properly coupled to the tractor.
- Lower the plough until the disk sets are supported in the soil. Adjust the nuts to the big rod just until they touch the spring support, without compressing it. Thus it is correctly adjusted for both work and transport.

***OBS: NOTE: IF YOU USE ANOTHER TRACTOR, WITH A DIFFERENT DRAWBAR HEIGHT, THIS ADJUSTMENT SHOULD BE REMADE.***

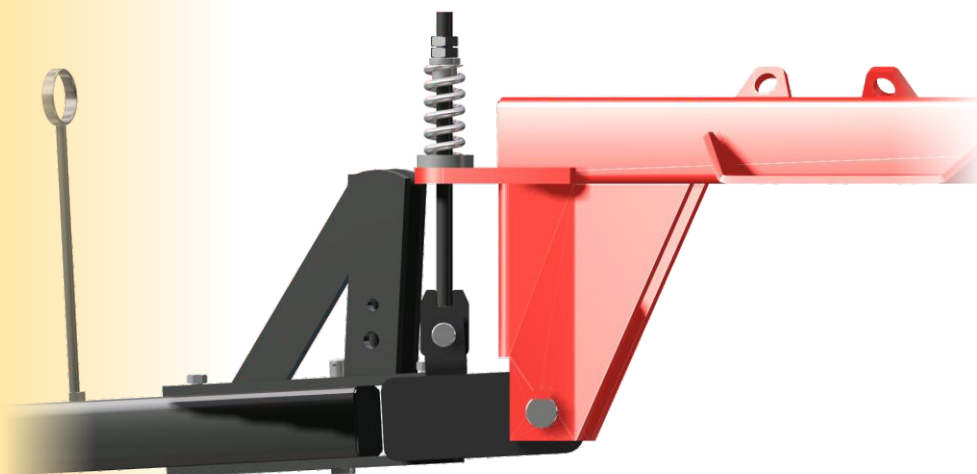

To transport the plough through longer distances, it is necessary to use the lock for the transport (A) that is coupled to the hydraulic cylinder rod along with the lock pin and lock R (B).

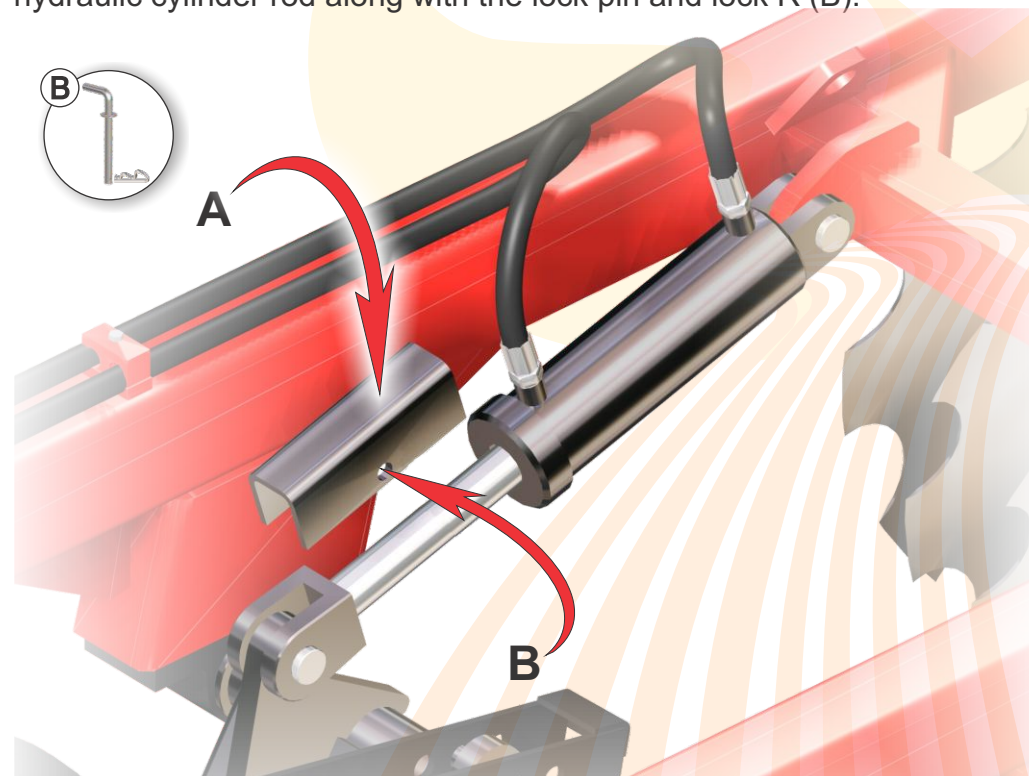

-Before starting the service, check the conditions of all the parts, retightening nuts and screws, mainly from the sections of discs, as working loose might damage the axles and other fastening components.

-Lubricate properly all the grease points.

# ADJUSTING AND OPERATIONS

## TRACTOR POSITION IN RELATION TO THE PRIOR STEP - SIDE DISPLACEMENT

Side displacement of the tractor is used to better position the tractor in relation to the groove of the prior step, avoiding leaving a track and giving a reference to the operator.

This positioning is obtained due to the gauge of the tractor and cutting width of the plough.

Whenever possible, the tractor should "move" on the soil not worked and close to the previous groove.

The displacement is done by changing the header in the coupling bar, as it follows :

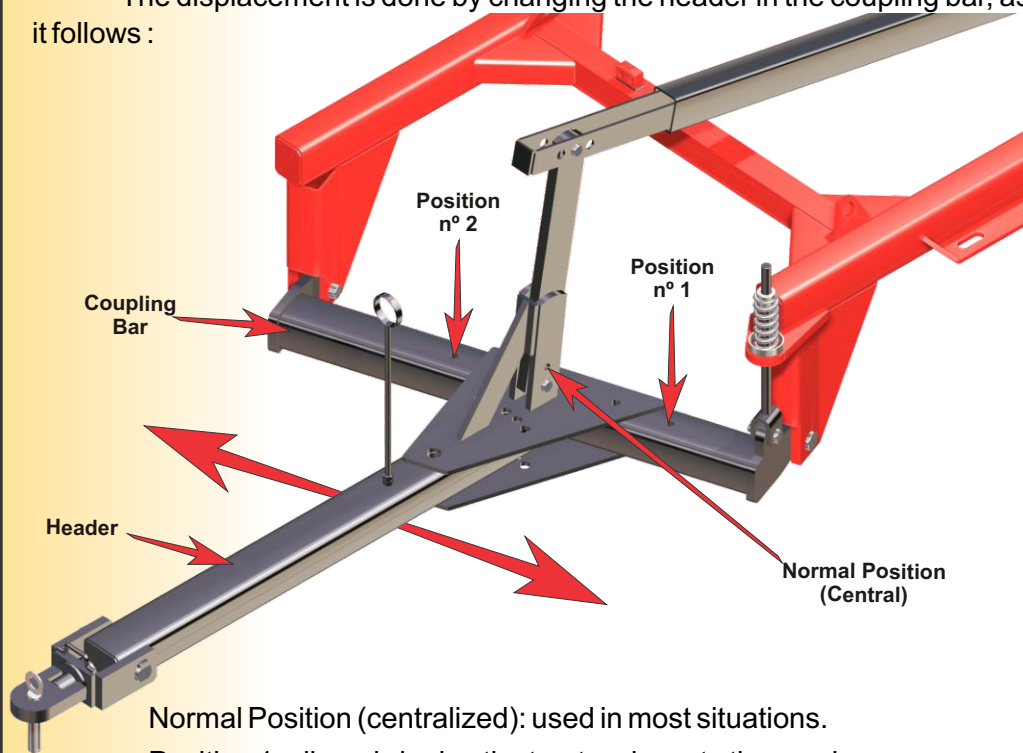

Normal Position (centralized): used in most situations.

Position 1: allows bringing the tractor closer to the previous groove.

Position 2: allows distancing the tractor from the previous groove.

**Obs.:** - When doing lateral displacement, the fixation of the stabilizing bar must also be changed (A), so that:

- In the normal position, use the holes 3 and 6 of the stabilizing bar
- In the position n° 1, use the holes 2 and 5 of the stabilizing bar
- In the position n° 2, use the holes 1 and 5 of the stabilizing bar



## TRACTION BAR ANGLES

In normal service conditions, during transport, the traction bar must operate in the central hole of the top and bottom plates.

Changing the bar for the other holes, small lateral displacements of the plough can be obtained.

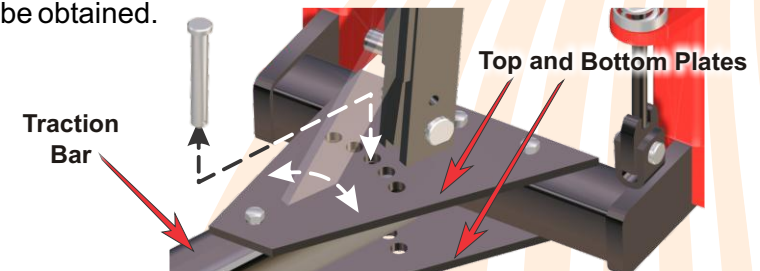

Resume:

- The GLCR and GICR ploughs are operating properly when they cover the trail of the tractor and when there are no deviations from the sides.
- The drawbars of the plough and the tractor must be as aligned as possible with the work direction.
- The tractor traction bar must remain loose when in operation and fixed when transported.



## CUT DEPTH

Basically the cut depth is regulated as follows:

- \* By activating the hydraulic cylinder so that the tires act as depth regulators;
- \* And by the most recommended form, which is regulating the opening of the disc sections (cut angle lock)

This regulation is made by displacing the chassis through the fixation holes on the right side of the frame (figure 10)

Usually to work on lands more difficult lands for plough penetration, increase the opening angle between the sections; on light and soft soils, decrease the opening angle.

**Observation:** We recommend controlling depth by the opening of the sections and use the tires only where the plough penetrates excessively.

In general, the front section does not work with an opening larger than the rear :

Fig.10

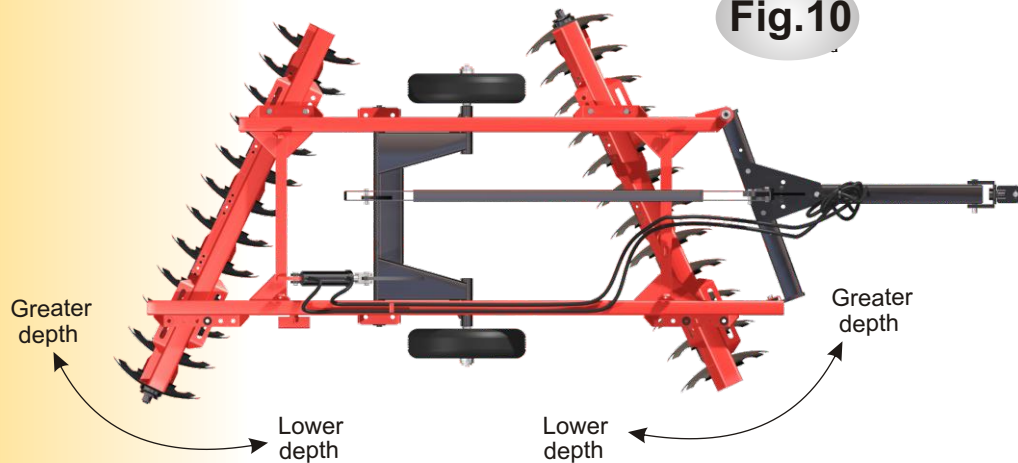

## ANGLING AND FIXATION OF WORK POSITIONS

Observe that the grated soil should always be on the left side of the operator (closed side of the plough)

Avoid forming bands without grating (windows), always trying to attain a good finishing between steps.

## SIDE DISPLACEMENT OF THE TRACTOR IN RELATION TO THE PRIOR STEP

Depending on the gouge of the tractor and the cut width of the plough, the side displacement of the tractor is used to better position the tractor in relation to the groove of the last step, avoiding leaving a track and giving a reference to the operator.

Whenever possible, the tractor should "move" on the soil not worked and close to the previous groove.

This is attained by displacing the header set by the plough traction bar.

**Note:** With the side displacement, the stabilizing bar fixation is also changed, according to need.

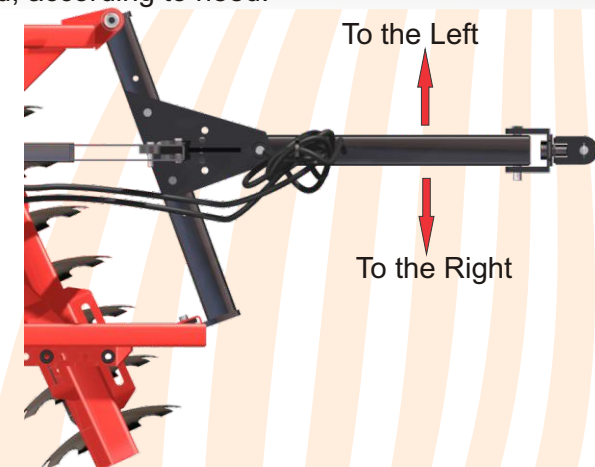

# FORMS TO INITIATE THE PLOUGHING

Regardless of the format and size of the terrain, the ploughings are basically made in two ways: from the outside to the inside or from inside to the outside.

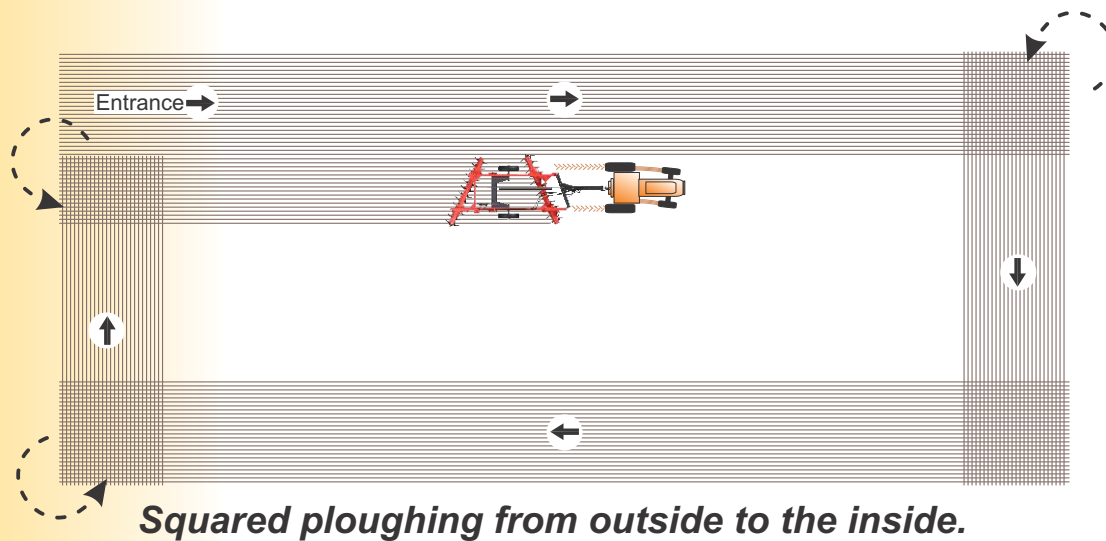
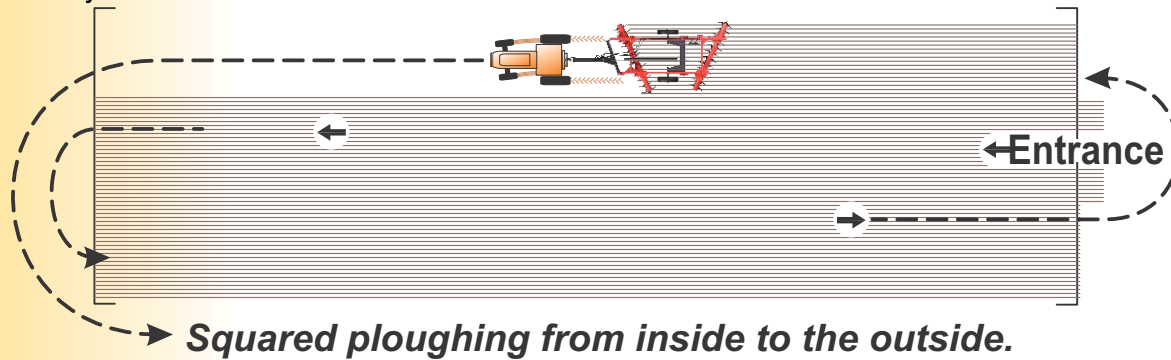

## Important:

Note that the ground ploughed must always be to the left of the operator.  
With the sections of discs lowered, drill manoeuvres only to the left. (closed side of the plough)

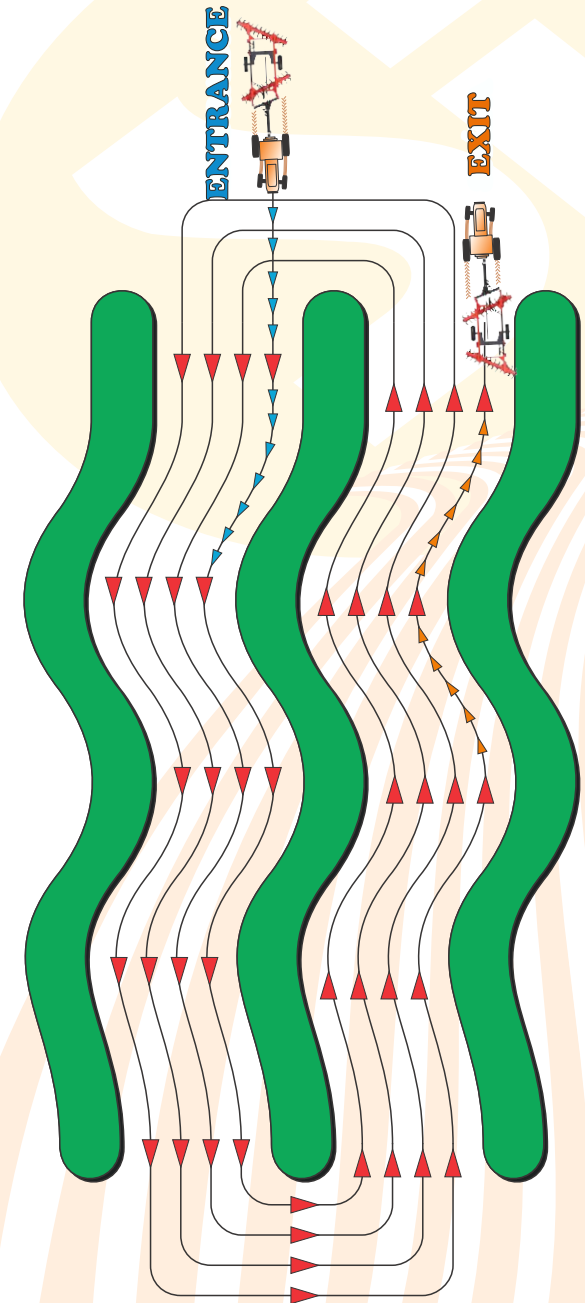



- Do not do any checking on the implement, without prior supporting the disks on the ground and switch off the engine.
- The high pressure leaks in the hydraulic circuit can cause bodily harm.
- Use adequate protection for this check;
- Wear gloves for protection for the handling of the discs or for its own protection;
- Do not transit on highways or paved roads, especially at night.
- When in long distances, use warning signs.

## MAINTENANCE

It is never too much to insist on the cares that should be taken with the implement:

- Daily retighten the nuts and screws of the implement;
- Perform daily lubrication;
- Keep the implement in a covered and humidity-clear place;
- Apply a thin layer of oil or used grease to the discs in order to prevent rust.

### LUBRICATION POINTS

- 1 - Hydraulic Cylinder
- 2 - Wheel Cubs
- 3 - Wheel axle bearings
- 4 - Bearings disc sets

 = Grease

 = Oil

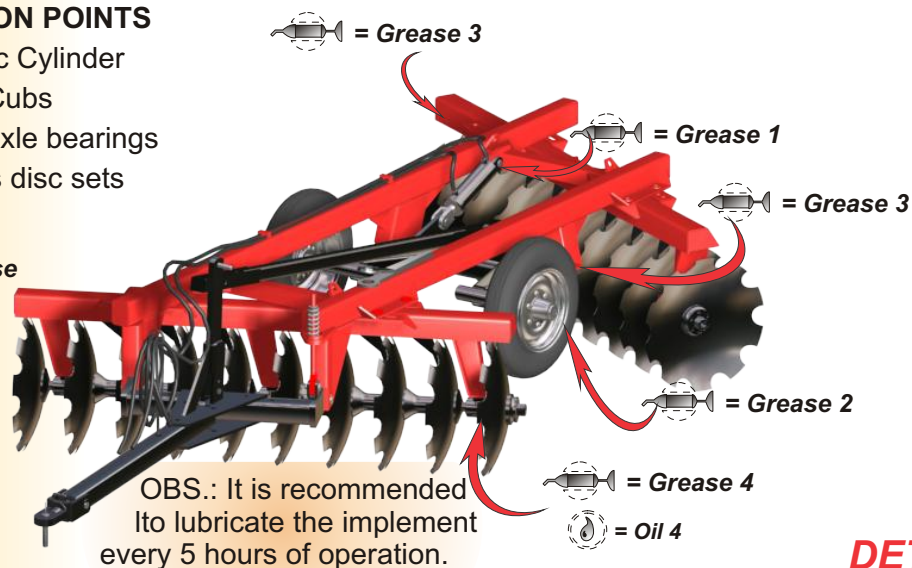

### DETAIL A

## SPECIAL CARES

### Retightening the disc set

It is necessary, in the first days working with the implement, to retighten its disc sets. It is desirable, even after these initial cares, to make least one daily observation, following the table below:

**1° Retightening after 04 hours of work.**

**2° Retightening after 08 hours of work.**

**3° Retightening after 16 hours of work.**

**4° Retightening after 36 hours of work.**

**Then run the retightening weekly**

To retighten the disc sets first slightly release the screws that connect their bearings in the body.

If the discs operate loosely, it is possible that, by friction, the faces of the spacers and bearings are worn out. In that case, the set should be taken out of the structure, retightened and the distance between the centre of its bearings, which should obey the limits given in figure 19.

If the distance is smaller than the one indicated, the compensating washers should be placed between the discs and the spacers, as shown in detail A.

Only then the set should be retightened, controlled and assembled back in its place.

### ATTENTION:

The lack of these cares will result in irreparable damages to the ball bearings and axles, not covered by the warranty.

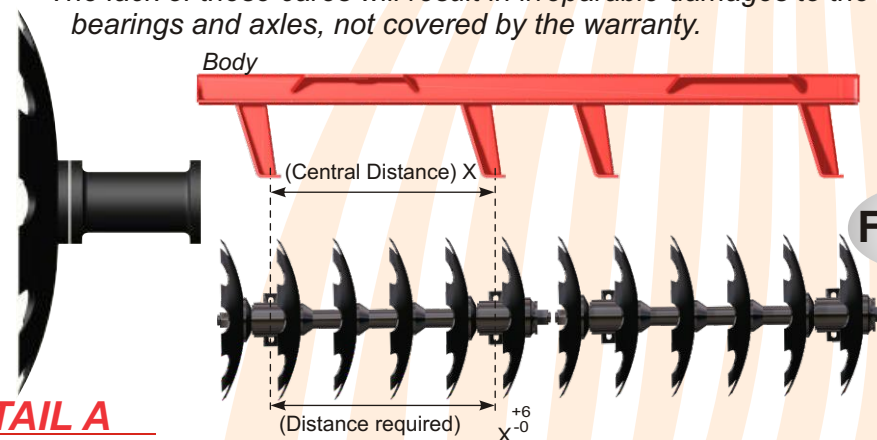

Fig.19

## IMPORTANT

- Check the oil level of the bearings and lubricate the grease points before starting the use of this implement.
- Repeat the inspection weekly.
- Observe if there are leaks daily.
- Change the oil every 1000 hours of operation.
- Use Ipiranga IPICIL – 1500 oil.
- Retighten the disc sets, periodically, keeping in mind that for that the bearing fixating screws should be released.
- Lubricate the grease points, periodically.

## LUBRICATION BEARINGS

- Before putting the plough to work for the first time, check the oil level of the bearings, by removing the "gas level indicator". The bearing will have a good oil level, if it spills through the hole where the plug was screwed. If the level needs to be filled up, use Ipiranga IPICIL – 1500 oil.
- A weekly inspection of the oil level is enough, but in the first days of operation, check for external indicators of oil leak or check the oil level daily. If there are leaks, disassemble the bearing, replace its retainers and mostly the bearing axle if there is wear in the area where the retainer is located.
- Oil changes should be made every 1000 hours of effective operation with the plough; as follows:

- a) Dry the plough bearings;
- b) Drain the oil through the existing plug;
- c) Fill up with Ipiranga IPICIL – 1500 oil.
- d) Check the oil level.

\* The existing plug on the framework (body) of the bearing, in addition to allows the introduction of oil, also serve as a level for the lubricant, thus providing the ideal measure of the oil quantity the bearing should contain. The bearing will have a good oil level, if this spills through the hole where the plug was screwed.

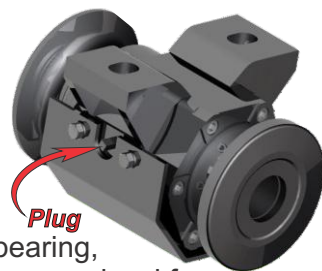

## LUBRICATION

The proper lubrication is indispensable for the operation and maintenance of the equipment to be enough. The main function of the lubricant is to form a layer, which involves the surface of the bearings, isolating them.

If there is no lubrication or if this is inadequate or deficient, the insulating layer ceases to exist and the components of the bearings start to friction between themselves, drastically shortening the life of the bearing.

The proper lubricant also lubricates the retaining rings, avoiding internal corrosion of the bearing and dissipating the heat generated by the bearings and retainers. The oil is a great lubricant for ball bearings.

The bearing should not be completely filled with oil, as the sun heat and the heat generated by the movable components of the bearing would cause the lubricant to expand, damaging the retainers or even the bearing case due to the pressure.

When the equipment is inoperative for a long period (for example during planting and harvesting), the bearings should spin a few times, so that the lubricant involves all their components, especially their upper parts, which may oxidize due to the long inactive period with the action of the existing air above the oil level. We suggest that the disc bearings and the wheel cubes to be moved (turned) at least twice a month.



## OPERATIONAL DATA AND SAFETY

- Choose the appropriate gear that enables the tractor to maintain a certain reserve of power, ensuring against unforeseen efforts;
- The average operating speed is determined by field conditions.
- A higher speed may compromise the service efficiency and cause damage to the implement. Following the speed limits below:

**Disc Plough: 5.0 km/h to 6.5 Km/h**

**Intermediate Plough: 7.0 km/h to 9.0 Km/h**

**Levelling Disc Plough: 10.0 km/h at 13.0 Km/h**

- Raise the disc sections while performing maneuvers in the headers, gradually activating the hydraulic cylinder;
- During operation (discs on the ground), do not perform maneuvers to the right as the angle formed by the disc sections transfers an excessive effort overloading mainly the traction components.
  - Remove any object (wood, wire) that may trap the discs;
  - By making any checking on the hydraulic cylinder, hoses, quick couplings, relieve the command pressure.
- When the plough is in transport (axles articulated downwards), not to exceed the maximum speed of 20 km/h.

### **SAFETY: Some cares to avoid accidents;**

- Only qualified people with knowledge on the tractor and the implement should operate them;
- Before starting the work, analyze the area to be worked on, delineating the dangerous locations;
- Do not allow any person, other than the tractor operator, to remain in the tractor or the implement during transport or work;



